

## Contents

Appliance Fronts . . . . .	M-2	Panel, Decorative Under Counter Refrigerator . . . . .	M-2
Beaded Panels . . . . .	M-3	Pricing Of Doors, 5-Part/Styled Or Slab/Styled Drawer Heads . . . . .	M-6
Casters . . . . .	M-5	Pricing Slab And Slab/Raised Panel Drawer Heads . . . . .	M-6
Drilling Only Pulls/Knobs . . . . .	M-7	Retractable Doors . . . . .	M-4
Drawer Boxes . . . . .	M-6	Routed Finger Pulls . . . . .	M-7
Finger Pulls, Routed . . . . .	M-7	Shelf Brackets . . . . .	M-4
Flutes . . . . .	M-4	Shelving, Solid Wood . . . . .	M-7
Hinges . . . . .	M-6	Solid Stock . . . . .	M-3
Door And Drawer Lock . . . . .	M-5	Solid Wood Beaded Moulding . . . . .	M-3
Magnetic Door Catches . . . . .	M-5	Solid Wood Tops . . . . .	M-4
Shelf Clips . . . . .	M-5	Stain & Glaze . . . . .	M-6
Paint & Top Coat . . . . .	M-6	Touch Up Kit . . . . .	M-5
Panels, Cut To Size . . . . .	M-3	Wine Cooler Door Frame . . . . .	M-2
Panel, Decorative Compactor . . . . .	M-2	Wood Mantle . . . . .	M-4
Panel, Decorative Dishwasher . . . . .	M-2	Wood Top Using Soft Down . . . . .	M-5
Panel, Decorative Ice Maker . . . . .	M-2	Wood Veneer Tops . . . . .	M-5
Panel, Decorative Refrigerator . . . . .	M-2		

## Items Only Available in Hampshire Custom line

Reeding . . . . .	M-8
Solid Maple Butcher Block Tops . . . . .	M-8

## Appliance Fronts

Decorator appliance fronts consist of 3/4" thick door (matching door style) mounted on a 1/4" panel. On all decorator panels (matching door style) when reveal specs are not given: DDP, DCP, DUCRP, DIMP will have a 5/16" reveal on top and sides and a 1 1/4" reveal on bottom.

DRP will have a 1" reveal on top and bottom and a 1 1/2" reveal on all sides.

All appliance front panel orders must include:

1. Make, model number and trim kit number, if applicable.
2. Exact size of each panel. If no 1/4" panel is required, you must specify thickness.
3. Any modifications needed, i.e. handle cutout, reveal specs, etc.

### Decorative Compactor Panel

DCP \$370 plus \$116 per panel

For inset or beaded panels, additional charges apply.

---

### Decorative Dishwasher Panel

DDP \$465 plus \$116 per panel

For inset or beaded panels, additional charges apply.

---

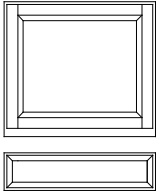

### Decorative Ice Maker Panel

DIMP \$370 plus \$116 per panel

For inset or beaded panels, additional charges apply.

---

### Decorative Refrigerator Panel

DRP \$945 plus \$116 per panel

For inset or beaded panels, additional charges apply.

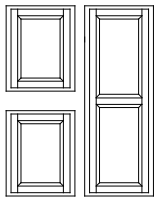

DRP 22 3/4" x 70 7/16"  
DRP 16 3/4" x 23 7/16"  
DRP 16 3/4" x 34 7/16"

---

### Decorative Under Counter Refrigerator Panel

DUCRP \$370 plus \$116 per panel

For inset or beaded panels, additional charges apply.

---

### Wine Cooler Door Frame

WINE FRAME \$249

## Solid Stock

3/4" solid stock is available. The face and one long edge will be finished.

If additional surfaces are required to be finished, this must be indicated on order. Minimum charge for solid stock \$50 List. Specify size.

SS (Up to 12" wide)	\$0.33	per sq. inch
SS (Wider than 12", max 30" wide, 96" tall)	\$96	per sq. ft

To add a decorative edge on solid stock, specify nosing detail and location of nosing. Edge choices below. The face and decorative edge will be finished. If additional surfaces are required to be finished, this must be indicated on order.

*i.e. DEC-STOCK 4" wide x 72" long, Type H-2 one long edge*

DEC-STOCK \$12 per linear ft.



## Panels, Cut To Size

Prices are for one side finished panels. If both sides need finished, add 25% to above prices.

1/2" and 3/4" Panels can be ordered with edges edge banded, specify which edges need banded and add \$12 per linear foot.

1/4" PANEL	Specify grain direction and size.	\$29	per sq. ft.
1/2" PANEL	Specify grain direction and size.	\$33	per sq. ft
3/4" PANEL	Specify grain direction and size.	\$40	per sq. ft

## Solid Wood Beaded Moulding

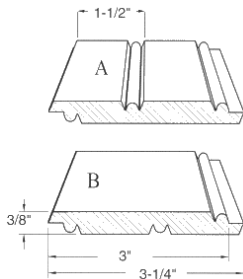

3/8" thick X 3 1/4" wide solid wood beaded strips (3" wide when finished) available in 4' or 8' lengths. G022 beading spaced 1 1/2" on side "A", and 3" on side "B". Must specify which side is exposed.

BEAD-PNL-A-4	\$102
BEAD-PNL-B-4	\$102
BEAD-PNL-A-8	\$203
BEAD-PNL-B-8	\$203

**NOTE: G056 beading not available in BEAD-PNL.**

## Beaded Panels

G022 & G056 are 2" on center.

Note: The Hampshire Co. does not recommend beading plywood when using light stains .

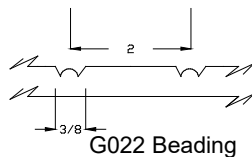

G022 BEADED	\$29	per sq. ft.
G056 BEADED	\$29	per sq. ft.

To add a beaded panel to the side of a cabinet L-R \$29 per sq. ft.

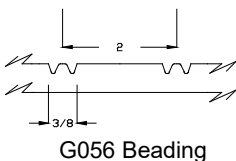

## Flutes

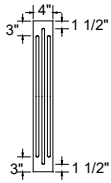

Flute(s) may be ordered on any piece of solid material, fillers, extended stiles, solid stock, etc. 3/8" flute width will be used unless specified otherwise. Specify how many, space between flutes, and distance from top and bottom.

Send drawing showing details.

FLUTE \$9 per flute, per ft.

## Wood Mantle

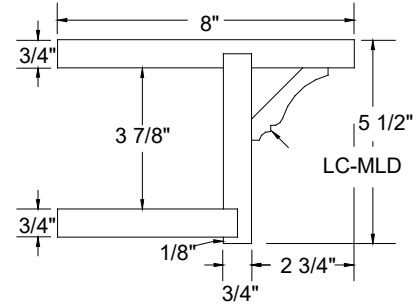
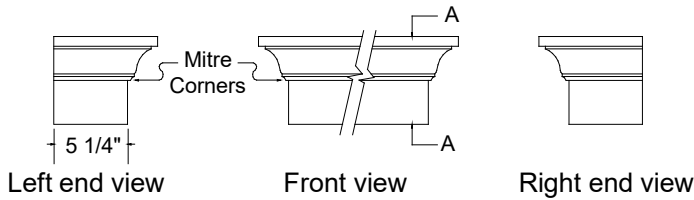

Section A-A

Wood mantle made out of 3/4" solid lumber and LC-MLD. Specify overall length of top - maximum width of 96"

Mantle will be manufactured with a front, mitered corners and a left and right end unless specified otherwise.

D-MAN \$214 per linear ft.

## Shelf Brackets

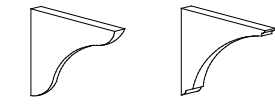

WSB-A

WSB-B

1 1/2" thick solid wood brackets available up to 12" x 12".

Specify size and type. Unless specified otherwise, 12" x 12" Type A will be furnished.

WSB-A	\$254	WSB-A with BRACE	\$304
WSB-B	\$254	WSB-B with BRACE	\$304
Custom WSB	\$280	Custom WSB with BRACE	\$335

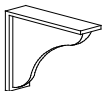

WSB-A with BRACE

## Retractable Doors

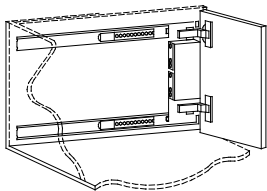

A ball bearing flipper slide that features an attached door that swings open and retracts into an opening. Deduct 7" from overall width of unit to determine clearance, when using butt doors.

RETRACTABLE \$786

Partitions may be installed in the unit to provide a pocket for the doors to conceal flipper slides or provide a space to install adjustable shelves. Deduct 9" from overall width of unit to determine clearance when using butt doors.

RETRAC/PART \$524

## Solid Wood Tops

3/4" thick solid wood top. Ends of top will not be finished unless specified. Maximum depth is 30". Specify length and depth, type of nosing, and edges that require nosing. Send drawing indicating location of nosing and size of top.

SOLID TOP TYPE \_\_\_\_\_ \$96 per sq. ft.

Wood tops over 96" will be spliced but not grained matched. Location of splice must be specified.

SPLICE \$183 per splice

Wood tops needing a mitre must show a drawing location.

MITER \$313 per miter

## Wood Top Using Soft Down

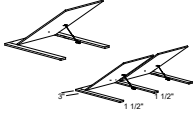

3/4" thick solid wood top used with soft down mechanism. May be used with Bench Cabinets - see section J. Maximum width is 36" using one lid, over 36" two lids necessary. Specify length, depth, type of nosing, and edges that require nosing.

i.e. LID WOOD TOP 60" x 25" Type LC-2 on both ends and front, split equally

LID WOOD TOP                      \$130    per sq. ft.

---

## Wood Veneer Tops

Veneered tops with bottom bracing and faced with 3/4" x 1 1/2" solid stock. Ends of top will not be finished unless specified. Maximum depth is 30". Specify length and depth, type of nosing, and edges that require nosing. Send drawing indicating location of nosing and size of top.

VENEER TOP TYPE \_\_\_\_\_                      \$74    per sq. ft.

Veneered tops over 96" long will be spliced but not grain matched. Specify location of splice.

SPLICE                      \$188    per splice

Veneered tops needing a miter must show a drawing location.

MITER                      \$313    per miter

---

## Casters

Casters may be ordered and attached to bottom of base cabinet. Overall height of cabinet (including casters) remains at 34 1/2". We recommend eliminating toekick and adding flush sub base to stabilize cabinet. Locking casters are also available. Specify for carpet or hard floor.

CASTERS ATTACHED                      \$613    per cabinet  
LOCKING CASTERS ATTACHED                      \$613    per cabinet

---

## Door And Drawer Lock

Keyed lock available for doors and drawers. Can not be used on butt doors or slab/raised panel drawer heads.

Available in Dull Chrome, Bright Brass, or Antique English.

DDL                      \$110    per lock

---

## Touch Up Kit

Touch up kit - includes a putty stick and touch up bottle.

Will automatically be added to each order of 3 or more units of the same wood species.

TUK                      \$54

---

## Magnetic Door Catches

Available on all cabinets. Are included in price for all beaded inset and inset door styles.

MAG DR CATCH                      \$10    per door

---

## Shelf Clips

Additional 1/4" shelf clips used on all cabinetry with adjustable shelves.

SHELF CLIPS                      \$0.67    per shelf clip

---

## Paint & Top Coat

Touch-up bottle	\$24
Pint	\$55
Quart	\$97
Gallon	\$324

## Stain & Glaze

Touch-up bottle	\$24
Pint	\$32
Quart	\$62
Gallon	\$216

Delivered only by Hampshire Truck. Cannot ship by UPS or USPS.

## Pricing Of Doors, 5-Part/Styled Or Slab/Styled Drawer Heads

When ordering additional doors or drawer heads, specify opening size and/or door size needed. Does not include hinges. You must give all information if ordering additional doors, 5 Part/Styled or Slab/Styled drawer heads.

The base price is \$91

+the square inches of the door multiplied by \$0.35

+the door charge specified in Section E.

*i.e Base charge \$91*

*+20 1/2" x 34 3/4" x \$0.35 = \$249.34*

*+(Traditional Door Style) charge*

Double panel doors entail additional cost. Specify side by side or top and bottom. See section E, DPD (Double panel doors) for more information and pricing.

## Pricing Slab And Slab/Raised Panel Drawer Heads

Specify opening size and/or drawer head size needed. Does not include drawer box.

You must give all information if ordering additional slab/raised panel drawer heads.

SLAB DRWR HEAD	\$0.35	per sq. inch
plus	\$57	per drawer head
SLAB/RAISED PANEL	\$0.35	per sq. inch
plus	\$57	per drawer head

## Hinges

### Inset Flush Hinge

Used on inset and beaded inset cabinetry.

Unless specified otherwise, DAE will be used on all stains and paints except Hampshire white paint. SB will be used on Hampshire white paint.

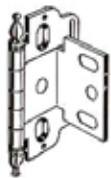

Soft Close hinged on overlay cabinetry comes standard in the Hampshire Custom lines. In

Stonebridge, overlay cabinetry can be upgraded to soft close hinges for \$17 per hinge.

Additional hinges ordered separately \$32 per hinge.

### Concealed Hinge

Used on 1/2", 1 1/4" or 1 3/8" overlay cabinetry when specified.

Soft Close Inset Concealed hinges on inset cabinetry comes standard in the Hampshire Custom lines. In Stonebridge, inset cabinetry can be upgraded to soft close concealed hinges for \$17 per hinge.



Additional hinges ordered separately \$12 per hinge.

### Hinge finishes available:

AE Antique English  
\*BB Burnished Brass  
\*DAE Dark Antique English  
edge profile

\*G10 Brushed Nickel  
\*RBZ Rustic Bronze  
\*ORB Oil Rubbed Bronze

\*SB Solid Brass  
\*WI Wrought Iron  
\*Not available when using H-2 or LC-2

## Drawer Boxes

To order a separate drawer box, specify opening of cabinet, cabinet depth, and drawer track being ordered separately.

Top drawer of a 12"-21" wide cabinet	\$232
Top drawer of a 24"-36" wide cabinet	\$272
Lower drawer of a 12"-21" wide cabinet	\$309
Lower drawer of a 24"-36" wide cabinet	\$347

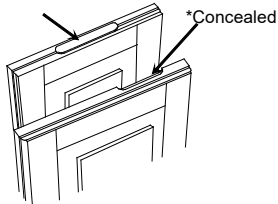

### Routed Finger Pulls

ROUTED FINGER PULL Standard or Concealed \$41 per finger pull

\*Not available with 1 1/4" overlay

### Drilling Only Pulls/Knobs

Please provide dimensions or drawings.

DRILL FOR KNOB	\$20	per drilling
DRILL FOR PULL	\$20	per drilling

### Solid Wood Shelving

3/4" thick solid wood, 12" deep. Finished all surfaces with edging detail. See section F for edge detail when necessary.

WOOD SHELVING \$71 per linear ft.



DEC EDGE 1  
EASED



DEC EDGE 2  
REEDED



DEC EDGE 3



DEC EDGE 4

### Reeding

**Reeding is the opposite of fluting**

Continuous single reeding is available on fillers, extended stiles, solid stock, etc. 1/4" wide reed with 1/8" between reeds. Reeding will run end to end. Indicate how many reeds. Send drawing showing details.

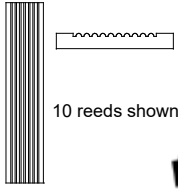

REEDING \$14 per reed, per foot

### Solid Maple Butcher Block Tops

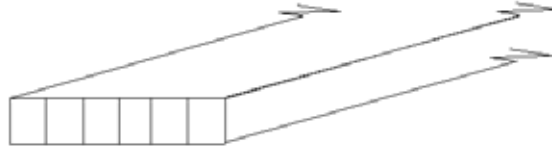

These tops come in two different grades. Commercial grade will have butt jointed rails and color variations. Furniture grade will have all full length rails and be selected for color.

Maximum length is 144" and maximum width is 42". Standard finish is a penetrating oil finish, but tops can also be finished using our stain and catalyzed varnish finish.

To specify grades, C = Commercial, F = Furniture. Pricing is for square edged top only.

#### 2 1/4" Thick Tops

##### Commercial Grade

SMBB 60 X 36 X 2 1/2	C	\$4,244
SMBB 72 X 36 X 2 1/2	C	\$6,005
SMBB 84 X 36 X 2 1/2	C	\$7,003
SMBB 60 X 48 X 2 1/2	C	\$9,205
SMBB 72 X 48 X 2 1/2	C	\$9,600
SMBB 84 X 48 X 2 1/2	C	\$11,200

##### Furniture Grade

SMBB 60 X 36 X 2 1/2	F	\$6,814
SMBB 72 X 36 X 2 1/2	F	\$8,179
SMBB 84 X 36 X 2 1/2	F	\$9,544
SMBB 60 X 48 X 2 1/2	F	\$10,919
SMBB 72 X 48 X 2 1/2	F	\$13,083
SMBB 84 X 48 X 2 1/2	F	\$16,077

#### 3" Thick Tops

##### Commercial Grade

SMBB 60 X 36 X 3	C	\$5,761
SMBB 72 X 36 X 3	C	\$6,809
SMBB 84 X 36 X 3	C	\$8,056
SMBB 60 X 48 X 3	C	\$9,224
SMBB 72 X 48 X 3	C	\$11,050
SMBB 84 X 48 X 3	C	\$12,895

##### Furniture Grade

SMBB 60 X 36 X 3	F	\$8,330
SMBB 72 X 36 X 3	F	\$10,013
SMBB 84 X 36 X 3	F	\$11,670
SMBB 60 X 48 X 3	F	\$13,327
SMBB 72 X 48 X 3	F	\$16,000
SMBB 84 X 48 X 3	F	\$18,636

Special pricing will apply for special sizes, angles, clips, edge detailing, etc. Send drawing for quote.